

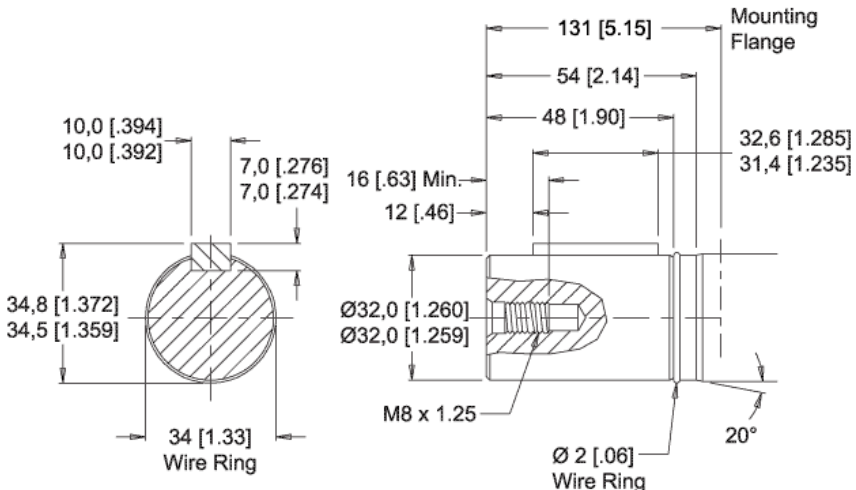

MODEL NO.
520375W3808AAAAA

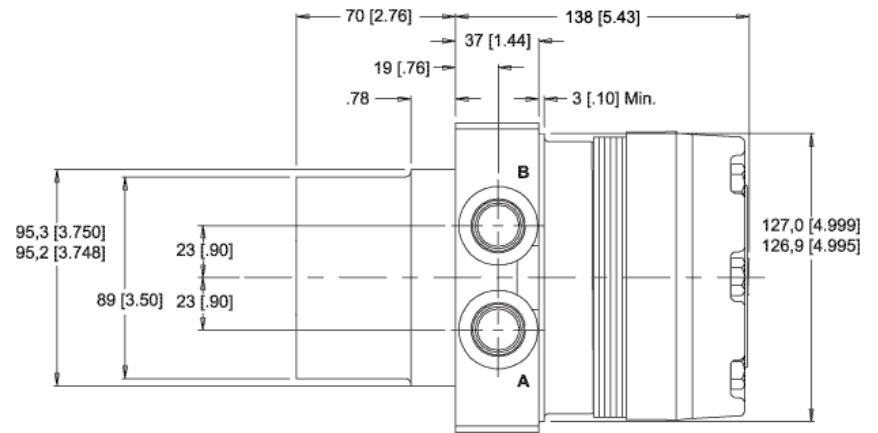
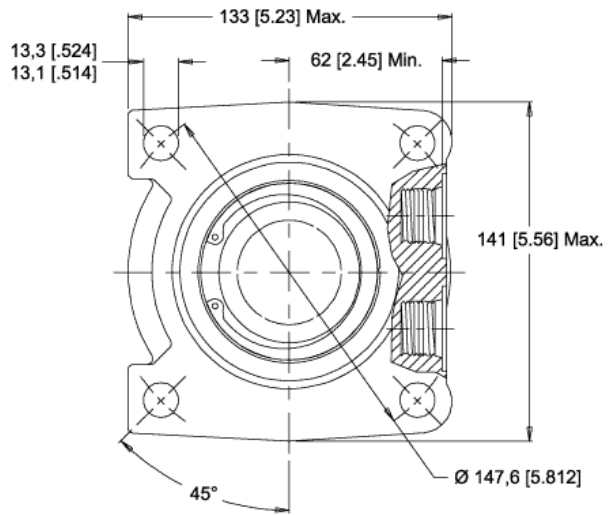

INFORMATION CONTAINED IN THIS DOCUMENT IS FOR REFERENCE ONLY AND VALID FOR 10 DAYS UNLESS SPECIFIED OTHERWISE. DIMENSIONS SHOWN ARE NOMINAL (MID-LIMIT). DIMENSIONS NEEDED FOR DESIGN PURPOSES. CONTACT WHITE DRIVE PRODUCTS, INC.

NOT FOR PRODUCTION USE

WHITE DRIVE PRODUCTS, INC
PO BOX 1127 · HOPKINSVILLE, KY 42240
PHONE: 270.885.1110 · FAX: 270.886.8462

	
DATE: 07/17/2014	DRAFT COPY
ISSUED BY: ONLINE CAD MODELS	
ISSUED TO: JESSE MIETTINEN	
MODEL NO. 520375W3808AAAAA	