

MODEL NO.
155080A6312BAAAA

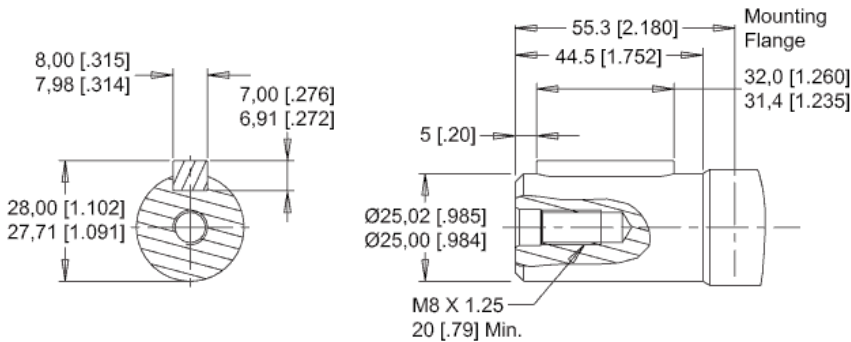

INFORMATION CONTAINED IN THIS DOCUMENT IS FOR REFERENCE ONLY AND VALID FOR 10 DAYS UNLESS SPECIFIED OTHERWISE. DIMENSIONS SHOWN ARE NOMINAL (MID-LIMIT). DIMENSIONS NEEDED FOR DESIGN PURPOSES. CONTACT WHITE DRIVE PRODUCTS, INC.

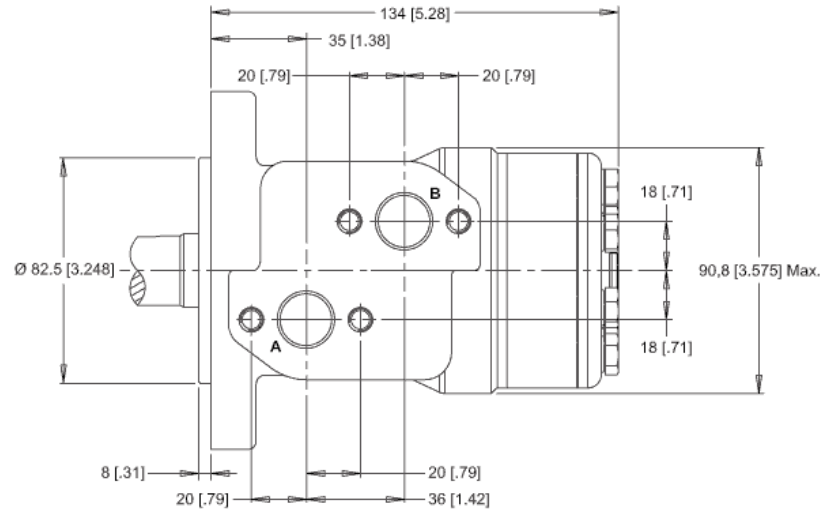
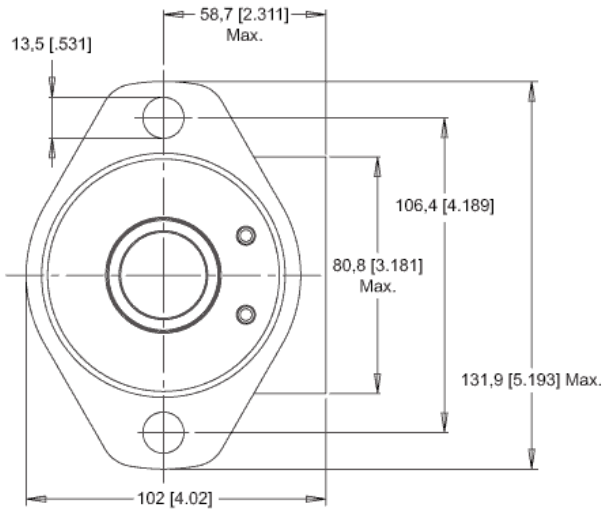

DATE: 07/17/2014 **DRAFT COPY**

ISSUED BY: ONLINE CAD MODELS

NOT FOR PRODUCTION USE

ISSUED TO: JESSE MIETTINEN

WHITE DRIVE PRODUCTS, INC
PO BOX 1127 · HOPKINSVILLE, KY 42240
PHONE: 270.885.1110 · FAX: 270.886.8462

MODEL NO.
155080A6312BAAAA