

MODEL NO.  
155125A6312BAAAA

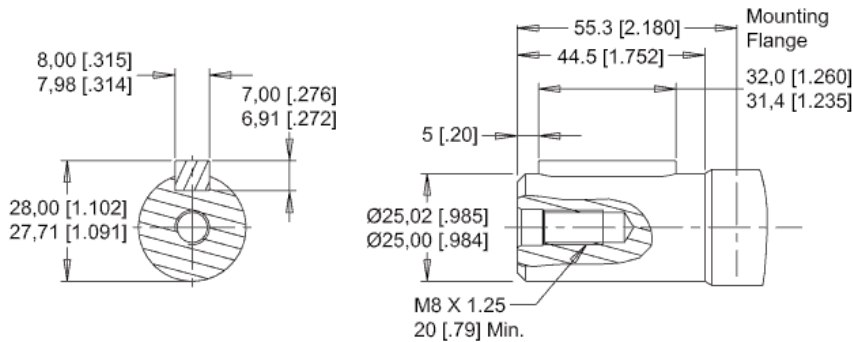

INFORMATION CONTAINED IN THIS DOCUMENT IS FOR REFERENCE ONLY AND VALID FOR 10 DAYS UNLESS SPECIFIED OTHERWISE. DIMENSIONS SHOWN ARE NOMINAL (MID-LIMIT). DIMENSIONS NEEDED FOR DESIGN PURPOSES. CONTACT WHITE DRIVE PRODUCTS, INC.

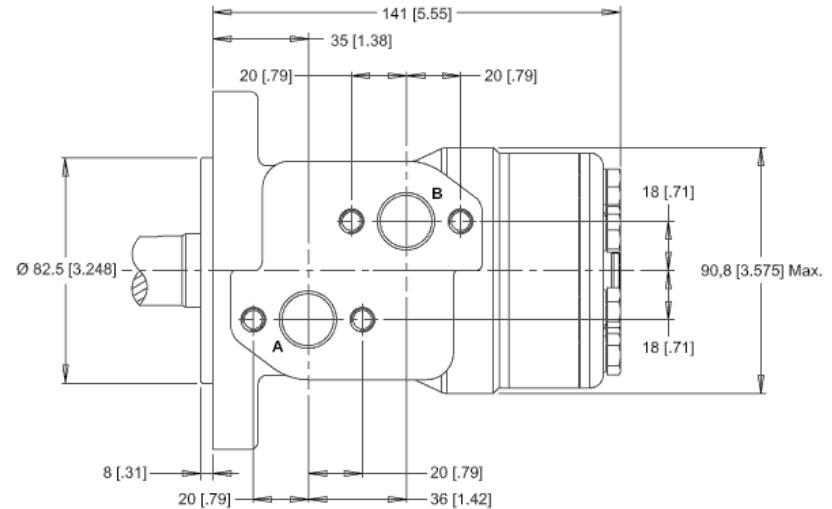
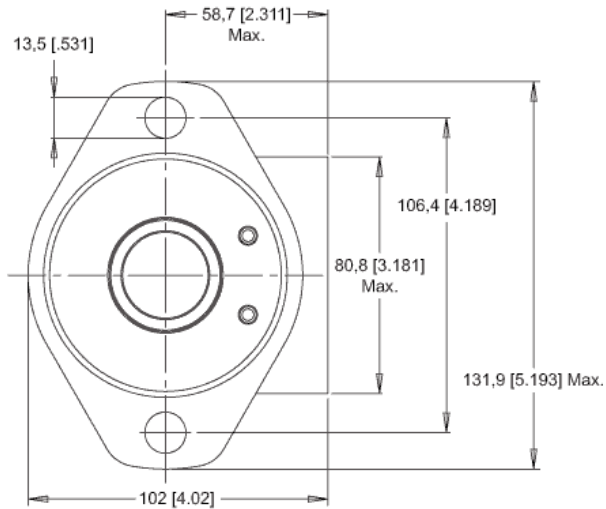

DATE:  
07/17/2014

**DRAFT COPY**

ISSUED BY:  
ONLINE CAD MODELS

**NOT FOR PRODUCTION USE**

ISSUED TO:  
JESSE MIETTINEN

WHITE DRIVE PRODUCTS, INC  
PO BOX 1127 · HOPKINSVILLE, KY 42240  
PHONE: 270.885.1110 · FAX: 270.886.8462

MODEL NO.  
**155125A6312BAAAA**