

ISO A

ACCIAIO
STEEL
STAHL
ACIER

Caratteristiche tecniche I

- Norma: ISO 7241 A
- Occlusione: valvola
- Aggancio: sfere radiali
- Materiale: acciaio
- Finitura: Zn-Fe (Cr III)
- Filettature: BSP - NPT - RC - SAE
- Guarnizioni standard: NBR
- Temperatura d'esercizio: -25 °C +100 °C
- Guarnizioni opzionali: FKM, FFKM, EPDM o altro
- Pressioni di esercizio: 160-350 bar
- Connessione in pressione: non consentita

Technical data E

- Standard: ISO 7241 A
- Occlusion: poppet
- Locking: radial balls
- Material: steel
- Finishing: Zn-Fe (Cr III)
- Threads: BSP - NPT - RC - SAE
- Standard seals: NBR
- Working temperature: -25 °C +100 °C
- Optional seals: FKM, FFKM, EPDM or more
- Working pressure: 160-350 bar
- Connection under pressure: not allowed

Technische Merkmale D

- Norm: ISO 7241 A
- Verschluss: ventil
- Kupplung: Radial Kugeln
- Werkstoff: Stahl
- Ausführung: Zn-Fe (Cr III)
- Gewinde: BSP - NPT - RC - SAE
- Standard-Dichtungen: NBR
- Betriebstemperatur: -25 °C +100 °C
- Dichtungen nach Wahl: FKM, FFKM, EPDM, usw.
- Betriebsdruck: 160-350 bar
- Kuppeln unter Druck: nicht möglich

Caracteristiques techniques F

- Norme: ISO 7241 A
- Obturation: clapet
- Accrochage: billes radiales
- Matériel: acier
- Traitement: Zn-Fe (Cr III)
- Taraudage: BSP - NPT - RC - SAE
- Joints standard: NBR
- Température de service: -25 °C +100 °C
- Joints facultatifs: FKM, FFKM, EPDM, ect.
- Pression de service: 160-350 bar
- Connexion sous pression: pas possible

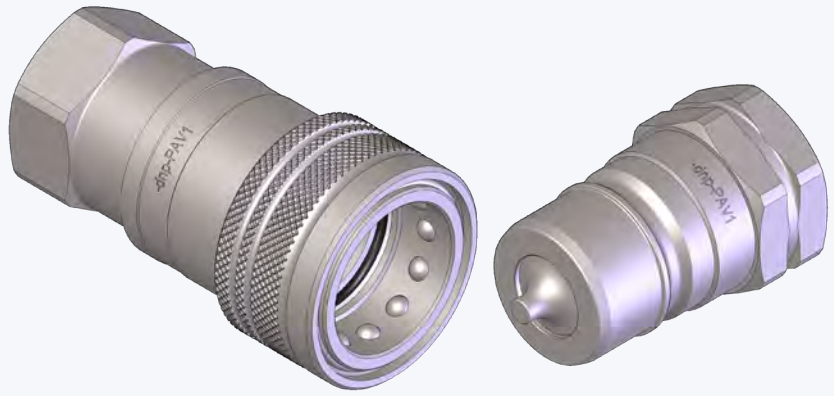

Nominal size				Max working pressure	Rated flow	Max flow rate	Min burst pressure			Fluid spillage
DNP	BG	ISO	mm				Male	Female	Coupled	
06	1	6.3	5	35	12	17	150	170	140	0.5
10	2	10	8.5	35	23	46	140	150	150	1.9
13	3	12.5	10.5	25	45	90	100	140	120	2.7
20	4	20	15.8	25	106	190	90	150	100	9.3
25	5	25	17.3	25	189	280	130	130	120	16
30	6	31.5	22.8	20	288	480	110	85	100	30
39	7	40	29.9	19	379	757	80	80	82	54
50	8	50	37.7	16	757	1000	65	96	100	120

1 MPa = 145.04 psi • 1 l = 0.264 gal

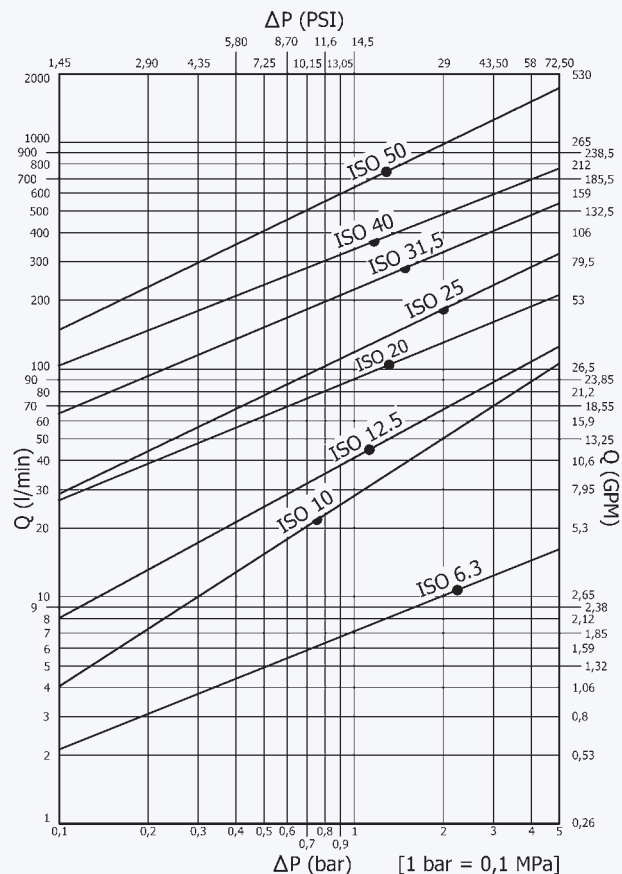

PAV1 DN06 - BG 1 - ISO 6.3

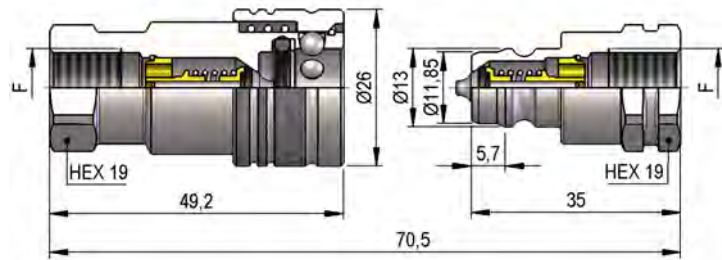

THREADS	F	STANDARD	FEMMINA - FEMALE - MUFFE - FEMELLE			MASCHIO - MALE - STECKER - MALE		
			COD. F	Weight (g)	Packaging (pcs.)	COD. M	Weight (g)	Packaging (pcs.)
IG 1	BSP 1/4"	DIN 3852-2-X	PAV1.0606.002	106	180	PAV1.0606.003	37	300
	NPT 1/4"	ANSI B1.20.3	PAV1.0606.012	107	180	PAV1.0606.013	38	300
	RC 1/4"	EN 10226	PAV1.0606.042	107	180	PAV1.0606.043	38	300
IG 2	9/16"-18 UNF 2B	SAE J 1926-1	PAV1.0615.032	102	180	PAV1.0615.033	34	300

PAV1 DN10 - BG 2 - ISO 10

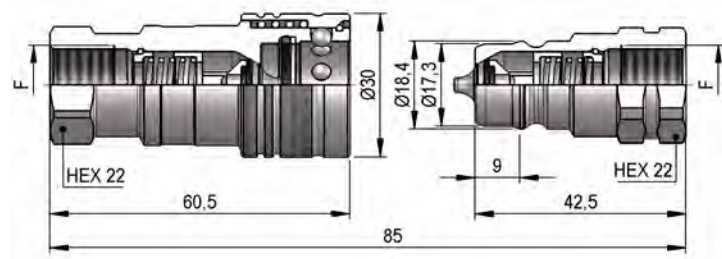

THREADS	F	STANDARD	FEMMINA - FEMALE - MUFFE - FEMELLE			MASCHIO - MALE - STECKER - MALE		
			COD. F	Weight (g)	Packaging (pcs.)	COD. M	Weight (g)	Packaging (pcs.)
IG 1	BSP 3/8"	DIN 3852-2-X	PAV1.1010.002	155	100	PAV1.1010.003	59	200
	NPT 3/8"	ANSI B1.20.3	PAV1.1010.012	156	100	PAV1.1010.013	60	200
	RC 3/8"	EN 10226	PAV1.1010.042	156	100	PAV1.1010.043	60	200
IG 2	9/16"-18 UNF 2B	SAE J 1926-1	PAV3.1015.032	175	100	See PPV3 DN10		
	3/4"-16 UNF 2B	SAE J 1926-1	PAV1.1019.032	184	100	PAV1.1019.033	63	200

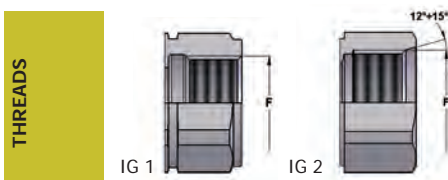

PAV1 DN13 - BG 3 - ISO 12.5

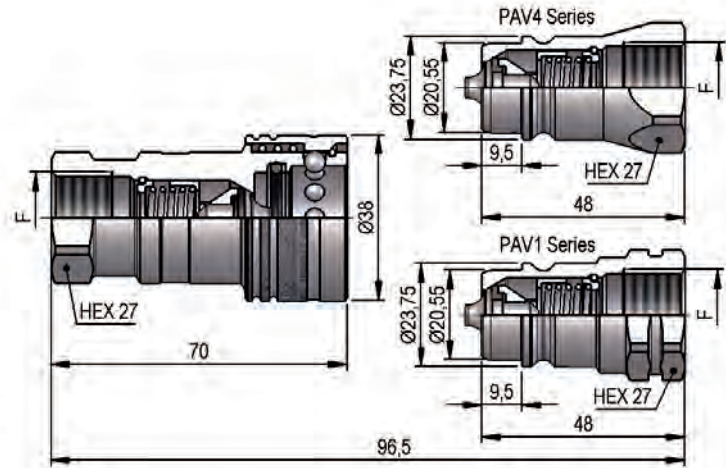

THREADS	F	STANDARD	FEMMINA - FEMALE - MUFFE - FEMELLE			MASCIO - MALE - STECKER - MALE		
			COD. F	Weight (g)	Packaging (pcs.)	COD. M	Weight (g)	Packaging (pcs.)
IG 1	BSP 1/2"	DIN 3852-2-X	PAV1.1313.002	268	50	PAV1.1313.003	97	200
	BSP 1/2"	DIN 3852-2-X				PAV4.1313.003	94	200
	NPT 1/2"	ANSI B1.20.3	PAV1.1313.012	269	50	PAV1.1313.013	98	200
	RC 1/2"	EN 10226	PAV1.1313.042	269	50	PAV1.1313.043	98	200
	NPT 3/4"	ANSI B1.20.3	PAV1.1319.012	353	50	See PKV		
IG 2	M22x1,5	SAE J 2244/1	PAV1.1322.102	260	50	PAV1.1322.103	90	200
	3/4"-16 UNF 2B	SAE J 1926-1	PAV1.1319.032	274	50	PAV4.1319.033	101	200
	7/8"-14 UNF 2B	SAE J 1926-1	PAV1.1323.032	260	50	See PKV		

PAV6 DN13 - BG 3 - ISO 12.5

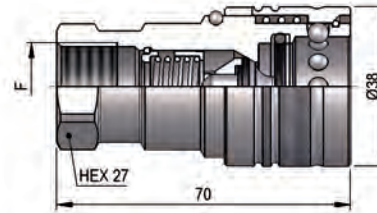

THREADS	F	STANDARD	FEMMINA - FEMALE - MUFFE - FEMELLE			MASCIO - MALE - STECKER - MALE		
			COD. F	Weight (g)	Packaging (pcs.)	COD. M	Weight (g)	Packaging (pcs.)
IG 1	BSP 1/2"	DIN 3852-2-X	PAV6.1313.002	292	50	See PAV1 DN13		
	NPT 1/2"	ANSI B1.20.3	PAV6.1313.012	294	50	See PAV1 DN13		
IG 2	7/8"-14 UNF 2B	SAE J 1926-1	PAV6.1323.032	290	50	See PKV		

PAV1 DN20 - BG 4 - ISO 20

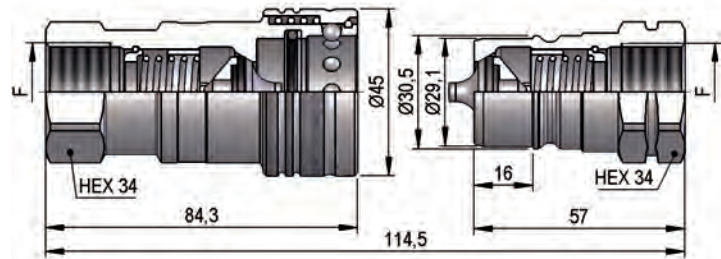

F	STANDARD	FEMMINA - FEMALE - MUFFE - FEMELLE			MASCIO - MALE - STECKER - MALE		
		COD. F	Weight (g)	Packaging (pcs.)	COD. M	Weight (g)	Packaging (pcs.)
BSP 3/4"	DIN 3852-2-X	PAV1.2019.002	428	28	PAV1.2019.003	180	45
NPT 3/4"	ANSI B1.20.3	PAV1.2019.012	434	28	PAV1.2019.013	186	45
RC 3/4"	EN 10226	PAV1.2019.042	434	28	PAV1.2019.043	186	45

THREADS

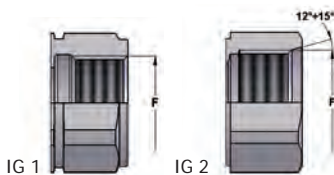

PAV1 DN25 - BG 5 - ISO 25

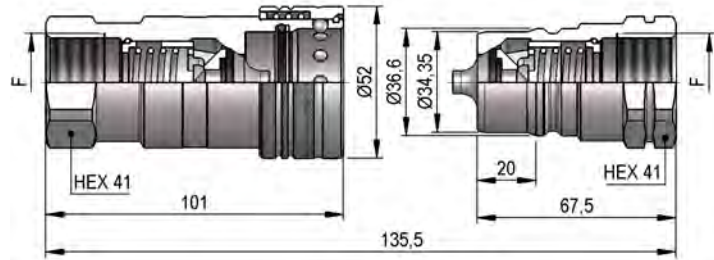

F	STANDARD	FEMMINA - FEMALE - MUFFE - FEMELLE			MASCIO - MALE - STECKER - MALE		
		COD. F	Weight (g)	Packaging (pcs.)	COD. M	Weight (g)	Packaging (pcs.)
BSP 1"	DIN 3852-2-X	PAV1.2525.002	700	20	PAV1.2525.003	304	30
NPT 1"	ANSI B1.20.3	PAV1.2525.012	708	20	PAV1.2525.013	313	30
RC 1"	EN 10226	PAV1.2525.042	708	20	PAV1.2525.043	313	30

PAV1 DN30 - BG 6 - ISO 31.5

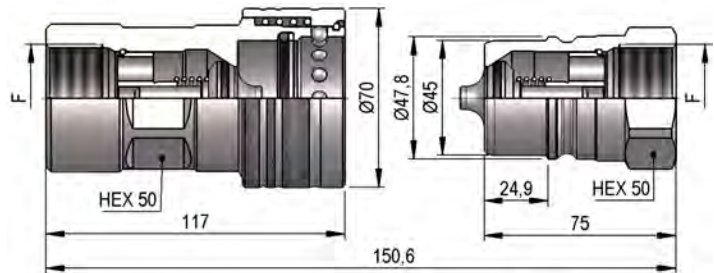

F	STANDARD	FEMMINA - FEMALE - MUFFE - FEMELLE			MASCIO - MALE - STECKER - MALE		
		COD. F	Weight (g)	Packaging (pcs.)	COD. M	Weight (g)	Packaging (pcs.)
BSP 1"¼	DIN 3852-2-X	PAV1.3031.002	1515	12	PAV1.3031.003	559	20
NPT 1"¼	ANSI B1.20.3	PAV1.3031.012	1532	12	PAV1.3031.013	572	20
RC 1"¼	EN 10226	PAV1.3031.042	1532	12	PAV1.3031.043	572	20

PAV1 DN39 - BG 7 - ISO 40

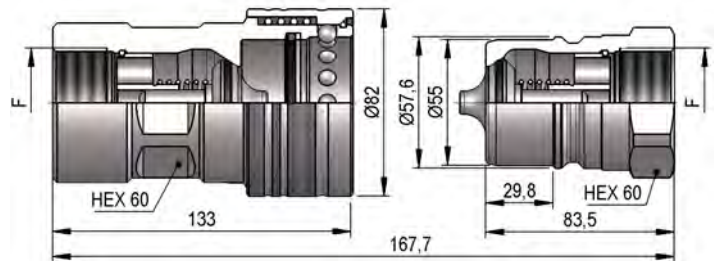

F	STANDARD	FEMMINA - FEMALE - MUFFE - FEMELLE			MASCIO - MALE - STECKER - MALE		
		COD. F	Weight (g)	Packaging (pcs.)	COD. M	Weight (g)	Packaging (pcs.)
BSP 1"½	DIN 3852-2-X	PAV1.3939.002	2445	8	PAV1.3939.003	918	12
NPT 1"½	ANSI B1.20.3	PAV1.3939.012	2464	8	PAV1.3939.013	938	12
RC 1"½	EN 10226	PAV1.3939.042	2464	8	PAV1.3939.043	938	12

PAV1 DN50 - BG 8 - ISO 50

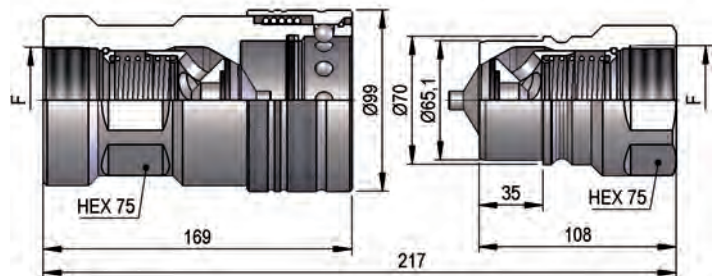

F	STANDARD	FEMMINA - FEMALE - MUFFE - FEMELLE			MASCIO - MALE - STECKER - MALE		
		COD. F	Weight (g)	Packaging (pcs.)	COD. M	Weight (g)	Packaging (pcs.)
BSP 2"	DIN 3852-2-X	PAV1.5051.002	5000	5	PAV1.5051.003	1804	8
NPT 2"	ANSI B1.20.3	PAV1.5051.012	5010	5	PAV1.5051.013	1820	8
RC 2"	EN 10226	PAV1.5051.042	5010	5	PAV1.5051.043	1820	8

PLASTIC CAPS

NOMINAL SIZE			FEMALE DUST PLUG				MALE DUST CAP				COLOR	MATERIAL		
DNP	BG	ISO	COD. F	Dimensions			Weight (g)	COD. M	Dimensions			Weight (g)		
				D	L	D1			D	L	D1			
06	1	6.3	SPAV.06002	24	127	19.5	7	SPAV.06003	24.5	123	18	9	●	PVC
10	2	10	SPAV.10002	28	220	22	14	SPAV.10003	23.5	220	22	16	●	PVC
10	2	10	SPAV.10022	28	220	22	14	SPAV.10023	23.5	220	22	16	●	PVC
10	2	10	SPAV.10032	28	220	22	14	SPAV.10033	23.5	220	22	16	●	PVC
10	2	10	SPAV.10042	28	220	22	14	SPAV.10043	23.5	220	22	16	●	PVC
13	3	12.5	SPAV.13002	35	250	26	20	SPAV.13003	29	250	26	21	●	PVC
13	3	12.5	SPAV.13012	35	250	26	20	SPAV.13013	29	250	26	21	●	PVC
13	3	12.5	SPAV.13022	35	250	26	20	SPAV.13023	29	250	26	21	●	PVC
13	3	12.5	SPAV.13032	35	250	26	20	SPAV.13033	29	250	26	21	●	PVC
13	3	12.5	SPAV.13042	35	250	26	20	SPAV.13043	29	250	26	21	●	PVC
13	3	12.5	SPAV.13052	35	250	26	20	SPAV.13053	29	250	26	21	○	PVC
13	3	12.5	SPAV.13062	35	250	26	20	SPAV.13063	29	250	26	21	●	PVC
20	4	20	SPAV.20002	42	270	36	33	SPAV.20003	36.5	270	36	39	●	PVC
20	4	20	SPAV.20012	42	270	36	33	SPAV.20013	36.5	270	36	39	●	PVC
20	4	20	SPAV.20032	42	270	36	33	SPAV.20033	36.5	270	36	39	●	PVC
20	4	20	SPAV.20042	42	270	36	33	SPAV.20043	36.5	270	36	39	●	PVC
20	4	20	SPAV.20052	42	270	36	33	SPAV.20053	36.5	270	36	39	○	PVC
20	4	20	SPAV.20062	42	270	36	33	SPAV.20063	36.5	270	36	39	●	PVC
25	5	25	SPAV.25002	54	235	41	46	SPAV.25003	49	235	41	53	●	PVC



METAL CAPS

NOMINAL SIZE			FEMALE DUST PLUG				MALE DUST CAP				MATERIAL		
DNP	BG	ISO	COD. F	Dimensions			Weight (g)	COD. M	Dimensions			Weight (g)	
				D	L	D1			D	L	D1		
06	1	6.3	SPAV.06202	19	160	30	11	SPAV.06203	19	180	30	18	Aluminum
10	2	10	SPAV.10202	30	200	33	42	SPAV.10203	30	200	33	50	Aluminum
13	3	12.5	SPAV.13202	38	205	32	51	SPAV.13203	38	205	32	70	Aluminum
20	4	20	SPAV.20202	45	275	47	66	SPAV.20203	45	275	47	107	Aluminum
25	5	25	SPAV.25202	43	240	41	59	SPAV.25203	45	290	41	119	Aluminum
30	6	31.5	SPAV.30202	70	275	47	119	SPAV.30203	70	275	47	280	Aluminum
39	7	40	SPAV.39202	83	275	47	170	SPAV.39203	83	275	47	453	Aluminum
50	8	50	SPAV.50202	99	275	47	297	SPAV.50203	99	275	47	731	Aluminum

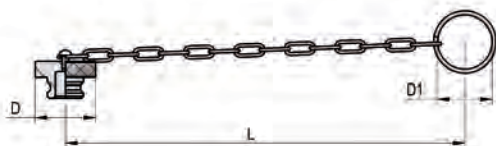

SPARE PARTS

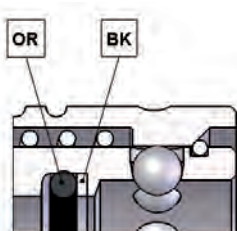

NOMINAL SIZE			FEMALE GASKET	
DNP	BG	ISO	OR (NBR*)	BK (PTFE)
06	1	6.3	PAV.006.120	PAV.006.130
10	2	10	PAV.010.120	PAV.010.130
13	3	12.5	PAV.013.120	PAV.013.130
20	4	20	PAV.019.120	PAV.019.130
25	5	25	PAV.025.120	PAV.025.130
30	6	31.5	PAV.030.120	PAV.030.130
39	7	40	PAV.039.120	PAV.039.130
50	8	50	PAV.050.120	PAV.050.130

*AL CODICE DELLA GUARNIZIONE IN NBR AGGIUNGERE 'E' PER EPDM O 'V' PER VITON

*TO THE NBR GASKET CODE ADD 'E' FOR EPDM OR 'V' FOR VITON

*ZU DER ARTIKELNR. DER NBR DICHTUNG GEBEN SIE 'E' FUER EPDM ODER 'V' FUER VITON AN

*AU CODE DU JOINT EN NBR JOINDRE 'E' POUR EPDM OU 'V' POUR VITON