

# MACH 7 Connectors

Coupleurs ISO - *ISO coupling* - ISO Kuppler

Coupleur NS - *NS coupling* - NS Kuppler

## PIÈCES DÉTACHÉES - SPARE PART LIST - TEILLISTE

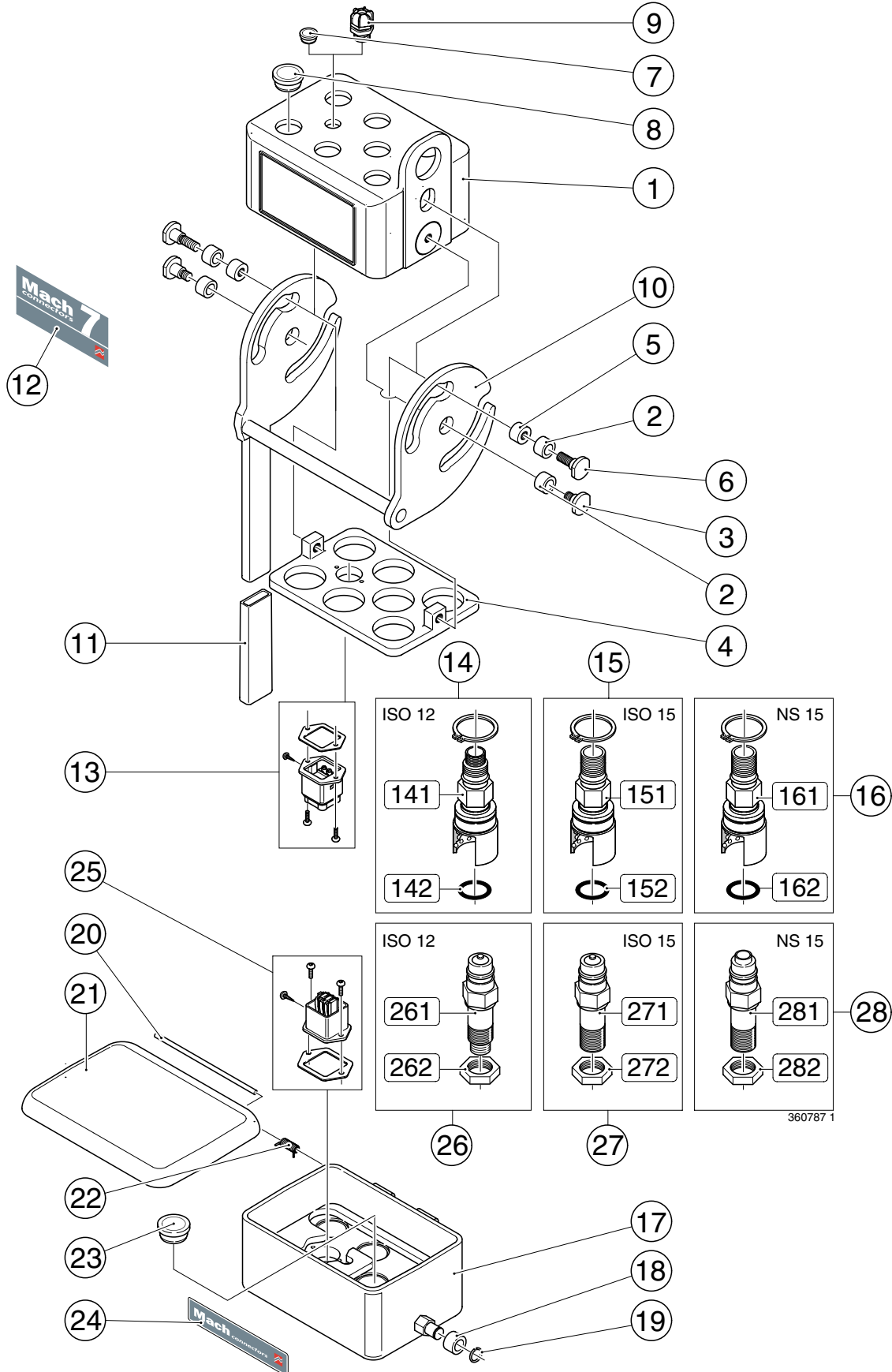



Rep. Fig. Oz	Référence Parts Nber Teile-Nr	Nbre Qty Menge	Dimension Maße	Désignation	Description	Bezeichnung
1	304014	1		CLOCHE NUE MACH 92	MACH 92 CLUTCH	MACH 92 GLOCKE
2	300597	4	D10 X 16/9	GALET	ROLLER	ROLLE
3	300593	2	M8 X 18	VIS	SCREW	SCHRAUBE
4	312985	1		PLAQUE INTERMEDIAIRE CLOCHE MACH92		
5	300599	2	M 8 X 16/10 ZBJ	ENTRETOISE	SPACER	DISTANZSTÜCK
6	300594	2	M 8 LG:29.5	VIS ÉPAULÉE	WASHER HEAD SCREW	BUNDSCHRAUBE
7	300501		D 10	BOUCHON PLASTIQUE	PLASTIC PLUG	KUNSTSOFFSTOPFEN
8	300502		D 23.6 X 28 H 12	BOUCHON PLASTIQUE	PLASTIC PLUG	KUNSTSOFFSTOPFEN
9	306337		PG 9	PRESSE ÉTOUPE	ELECTRIC GLAND	KABELDURCHFÜHRUNG
10	312986	1		CAME DE VERROUILLAGE MACH 92 ET MACH 7	LOCK CAM MACH 92 ET MACH 7	VERRIEGELUNGSGRIFF
11	300509	1	25 X 6	POIGNÉE PLASTIQUE	PLASTIC HANDLE	PLASTIKGRIFF
12	301373	1		ADHESIF "MACH CONNECTORS"	"MACH CONNECTORS"	"MACH CONNECTORS" AUFKLEBER
13	312794	1		CONNECTEUR FEMELLE	PLASTIC PLUG	KUNSTSOFFSTOPFEN
14	312774			MACH7 CONNECTOR ENS COUPL FEM CLOCHE 12		
141	305694	1	F 1/2-CL 18X150	COUPLEUR FEMELLE	FEMALE COUPLING	KOPPLERMUFFE
142	305414	1	D 20,29 X 2,62	JOINT TORIQUE	O-RING SEAL	O-RING
15	312772			MACH7 CONNECTOR ENS COUPL FEM CLOCHE 15		
151	305690	1	F 1/2 - CL 22 X 150	COUPLEUR FEMELLE	FEMALE COUPLING	KUPPLERMUFFE
152	305414	1	D 20,29 X 2,62	JOINT TORIQUE	O-RING SEAL	O-RING
16	510508		CLOCHE 15 NS	MACH7 CONNECTOR ENS COUPL FEM	MACH7 CONNECTOR ENS COUPL FEM	MACH7 CONNECTOR ENS COUPL FEM
161	510266	1	1/2 CL22X150	COUPLEUR FEMELLE	COUPLEUR FEMELLE	COUPLEUR FEMELLE
162	510507	1	BLC D 20.29 x 2.62	JOINT TORIQUE	O-RING SEAL	O-RING
17	300439	1		SOCLE NU MACH 92	BASE MACH 92	SOCKEL MACH 92
18	300597	2	D10 X 16/9	GALET	ROLLER	ROLLE
19	304841	2	E 10	ANNEAU ÉLASTIQUE	ELASTICATED RING	ELASTIQUE RING
20	313534	1		BROCHE	PIVOT PIN	SPINDEL
21	300518	1		COUVERCLE MACH 92	COVER MACH 92	ABDECKUNG MACH 92
22	300483	1		RESSORT	SPRING	FEDER
23	300502	0	D 23.6 X 28 H 12	BOUCHON PLASTIQUE	PLASTIC PLUG	KUNSTSOFFSTOPFEN
24	301373	1		ADHESIF "MACH CONNECTORS"	"MACH CONNECTORS"	"MACH CONNECTORS" AUFKLEBER
25	312793	1		MACH7 CONNECTEUR ENSEMBLE ÉLECTRIQUE MÂLE SOCLE	MACH7 MAL ELECTRICAL CONNECTOR UNIT	MACH7 STECKER
26	312775			MACH7 CONNECTOR ENS COUPL MALE SOCLE 12	MACH7 CONNECTORS MALE COUPL ASM BASE 12	MACH7 CONNECTORS MÄNNLICH KOPP-EINHEIT SOCKET12
261	305692	1	M 1/2-CL 18X150	COUPLEUR MALE	MALE COUPLING	KOPPLER-VATERTEIL
262	305979	1	HM 22 P:1.5 8.8 ZBJ	ECROU MINCE	THIN NUT	FLACHE MUTTER
27	312773			MACH7 CONNECTOR ENS COUPL MALE SOCLE 15		
271	305688	1	M1/2 CL - 22 X 150	COUPLEUR MÂLE	MALE COUPLING	KUPPLER-VATERTEIL
272	305979	1	HM 22 P:1.5 8.8 ZBJ	ECROU MINCE	THIN NUT	FLACHE MUTTER
28	510512		SOCLE 15 NS	MACH7 CONNECTOR ENS COUPL MALE	MACH7 CONNECTOR ENS COUPL MALE	MACH7 CONNECTOR ENS COUPL MALE
281	510265	1	1/2 CL22X150	COUPLEUR MALE	COUPLEUR MALE	COUPLEUR MALE
282	305979	1	HM 22 P:1.5 8.8 ZBJ	ECROU MINCE	THIN NUT	FLACHE MUTTER

# MACH 7 Connectors

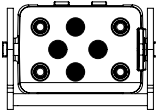
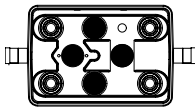
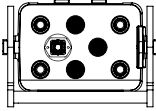
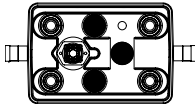
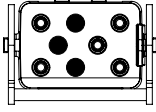
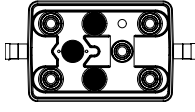
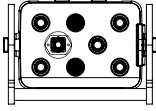
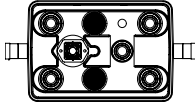
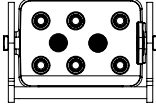
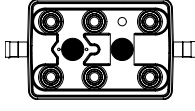
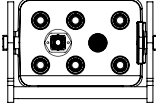
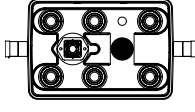
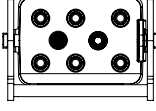
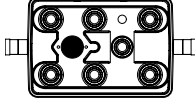
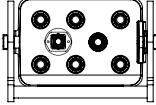
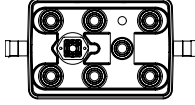

Coupleurs ISO - ISO coupling - ISO Kuppler



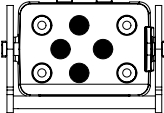
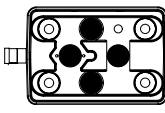
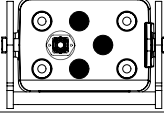
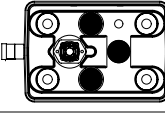
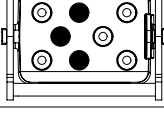
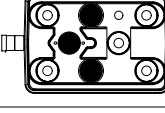
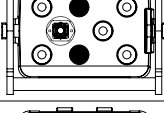
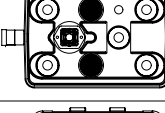
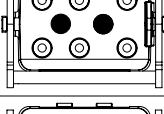
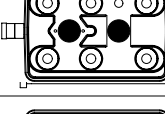
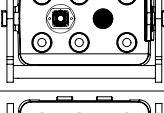
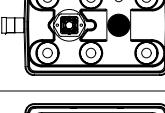
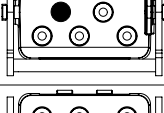
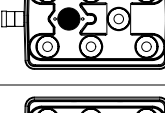
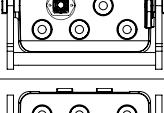
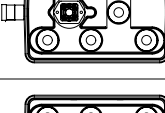
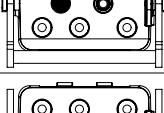
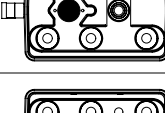

MACH 7 CONNECTORS 18 x 150 / ISO			
CLOCHE CLUTCH GLOCKE		SOCLE BASE SOCKEL	
	Ref : 334 740		Ref : 334 714
	Ref : 334 742		Ref : 334 715
	Ref : 334 743		Ref : 334 716
	Ref : 334 744		Ref : 334 717
	Ref : 334 745		Ref : 334 718
	Ref : 334 746		Ref : 334 719
	Ref : 334 747		Ref : 334 720
	Ref : 334 748		Ref : 334 721

-  Coupleur 1/2CL 18 x150 ISO - **1/2CL 18 x 150 ISO coupling** - 1/2CL 18 x150 ISO-Kuppler
-  Ensemble électrique - **Electrical assembly** - Elektrische Baugruppe
-  Bouchon - **Cap** - kappe

# MACH 7 Connectors



Coupleurs ISO - ISO coupling - ISO Kuppler



MACH 7 CONNECTORS 22 x 150 / ISO			
CLOCHE CLUTCH GLOCKE		SOCLE BASE SOCKEL	
	Ref : 334 731		Ref : 334 705
	Ref : 334 732		Ref : 334 706
	Ref : 334 733		Ref : 334 707
	Ref : 334 734		Ref : 334 708
	Ref : 334 735		Ref : 334 709
	Ref : 334 736		Ref : 334 710
	Ref : 334 737		Ref : 334 711
	Ref : 334 738		Ref : 334 712
	Ref : 334 726		Ref : 334 725
	Ref : 334 727		Ref : 334 722

-  Coupleur 1/2CL 18 x150 ISO - **1/2CL 18 x 150 ISO coupling** - 1/2CL 18 x150 ISO-Kuppler
-  Coupleur 1/2CL 22 x150 ISO - **1/2CL 22x 150 ISO coupling** - 1/2CL 22 x150 ISO-Kuppler
-  Ensemble électrique - **Electrical assembly** - Elektrische Baugruppe
-  Bouchon - **Cap** - kappe

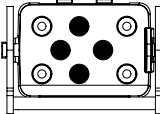
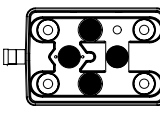
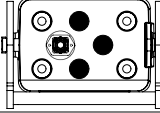
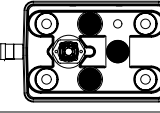
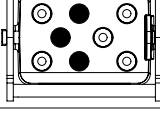
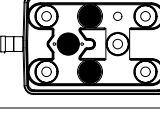
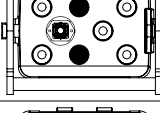
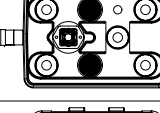
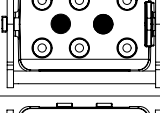
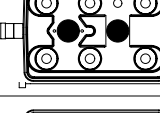
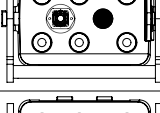
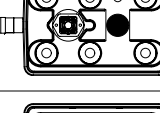
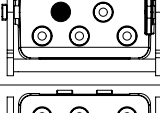
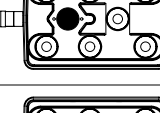
# MACH 7 Connectors

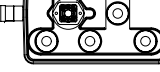
Coupleurs NS - *NS coupling* - NS Kuppler

MACH 7 CONNECTORS 22 x 150 / NS			
CLOCHE CLUTCH GLOCKE		SOCLE BASE SOCKET	
	Ref : 510 487		Ref : 510 490
	Ref : 510 491		Ref : 510 492
	Ref : 510 493		Ref : 510 494
	Ref : 510 495		Ref : 510 496
	Ref : 510 497		Ref : 510 498
	Ref : 510 499		Ref : 510 500
	Ref : 510 501		Ref : 510 502
	Ref : 510 503		Ref : 510 504

-  Coupleur 1/2CL 22 x150 NS - **1/2CL 22x 150 NS coupling** - 1/2CL 22 x150 NS-Kuppler
-  Ensemble électrique - **Electrical assembly** - Elektrische Baugruppe
-  Bouchon - **Cap** - kappe

# Socle de parking - *Parking base* - Sockelablage

## PIÈCES DÉTACHÉES - *SPARE PART LIST* - TEILLISTE

334 703

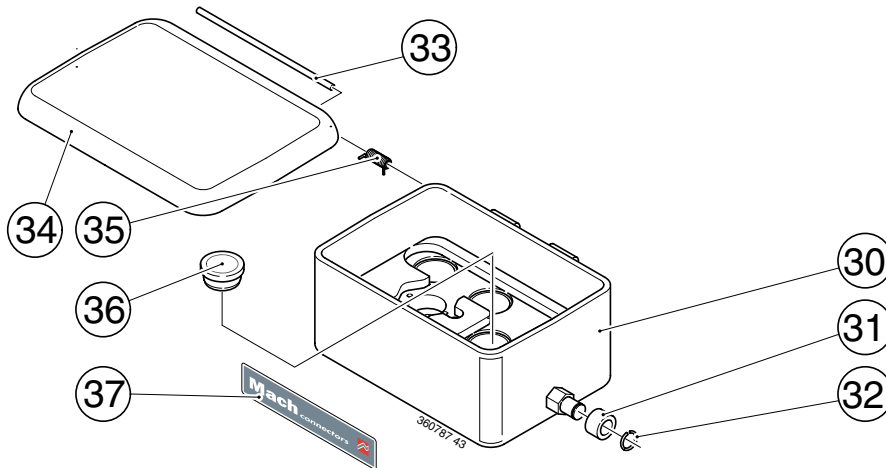

Rep. Fig. Oz	Référence Parts Nber Teile-Nr	Nbre Qty Menge	Dimension Maße	Désignation	Description	Bezeichnung
30	300439	1		SOCLE NU MACH 92	BASE MACH 92	SOCKEL MACH 92
31	300597	2	D10 X 16/9	GALET	ROLLER	ROLLE
32	304841	2	E 10	ANNEAU ÉLASTIQUE	ELASTICATED RING	ELASTIQUE RING
33	313534	1		BROCHE	PIVOT PIN	SPINDEL
34	300518	1		COUVERCLE MACH 92	COVER MACH 92	ABDECKUNG MACH 92
35	300483	1		RESSORT	SPRING	FEDER
36	300502	8	D 23.6 X 28 H 12	BOUCHON PLASTIQUE	PLASTIC PLUG	KUNSTSTOFFSTOPFEN
37	301373	1		ADHESIF "MACH CONNECTORS"	"MACH CONNECTORS"	"MACH CONNECTORS" AUFKLEBER

# Réserveur et support - *Tank and support* - Behälter un Halter

## PIÈCES DÉTACHÉES - *SPARE PART LIST* - TEILLISTE

319 943

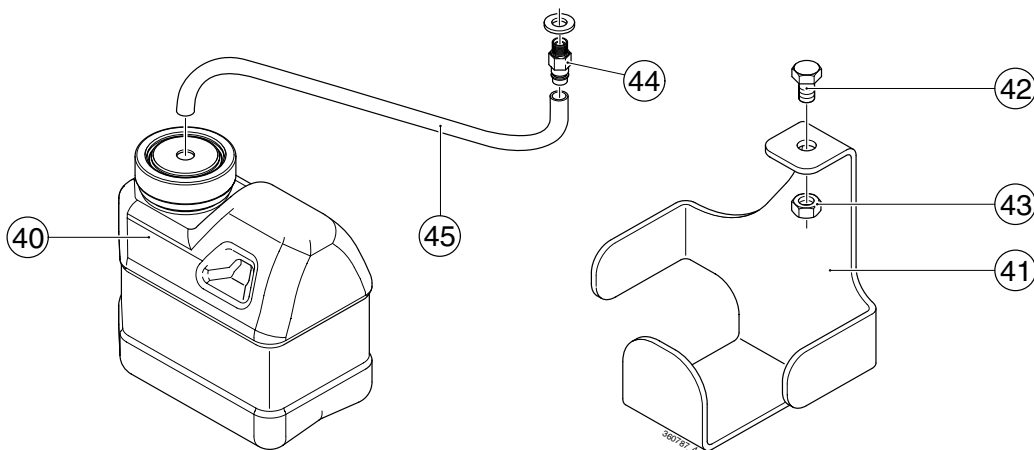

Rep. Fig. Oz	Référence Parts Nber Teile-Nr	Nbre Qty Menge	Dimension Maße	Désignation	Description	Bezeichnung
40	333521	1		RÉSERVOIR	TANK	TANK
41	333391	1		SUPPORT RESERVOIR	TANK SUPPORT	BEHÄLTERHALTER
42	304045	1	HM8 X 30 P:1.25 8.8 ZBJ	VIS	SCREW	SCHRAUBE
43	304602	1	HFR M8 P:1.25 8.8 ZBJ	ECROU FREIN	STOP NUT	STOPPMUTTER
44	306056	1		UNION	UNION	VERBINDUNGSSTÜCK
45	312133	1	D 5,5 X 8 LG 450 MM	DURITE	TUBE	SCHLAUCH