

RYCO

IN-LINE SWIVEL



THE **NEW** STANDARD IN SWIVELS

CONNECTING PARTNERSHIPS

www.RYCO.com.au

IN-LINE SWIVEL

THE **NEW** STANDARD IN SWIVELS

RYCO's In-Line Swivel works at higher pressures, has the lowest torque and last longer than others.



ELIMINATES HOSE TWISTS

EASY TO ROTATE

EXTENDED LIFE

PULSED AT 420 BAR / 6,100 PSI

BUILT TO LAST

SELF LUBRICATING

HIGH PRESSURE
LOW TORQUE
LONG LIFE





**PULSED AT 420 BAR / 6100 PSI WITH
ALTERNATING 90° ROTATION
FOR 500,000 CYCLES**

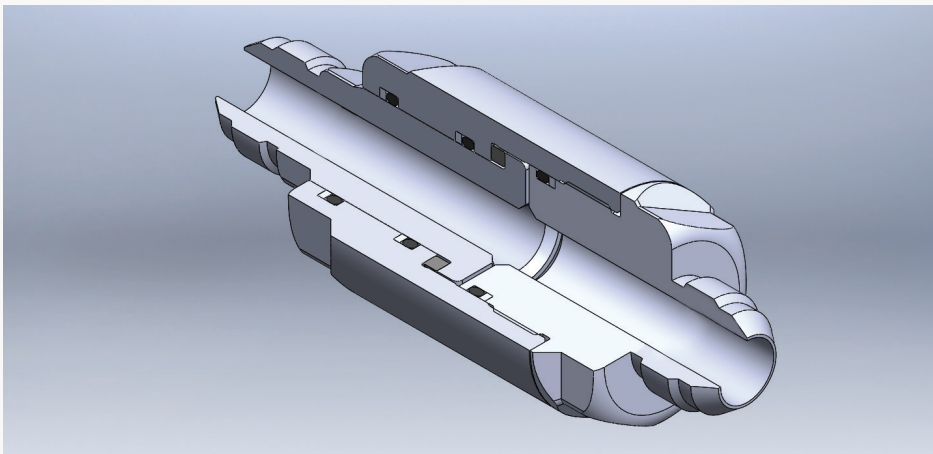

**SELF LUBRICATING
BUILT TO LAST**

HIGH PERFORMANCE MATERIAL

RYCOTE plated high performance steel components. Synthetic rubber seal (Viton seal upon request). Also available in stainless steel.

OPERATING TEMPERATURE

-40°C to +100°C (-40°F to 212°F)

SEAL KITS

Seal Kits are available.

BUILT FOR RUGGED CONDITIONS

Will not separate under extreme operating conditions and has excellent wear characteristics.

BI-DIRECTIONAL 360° SWIVEL

RYCO's In-Line Swivels are for applications where alternate rotation may be necessary.

IN-LINE SWIVEL SPECIFICATIONS		
SERIES	END 1	END 2
RS27P	BSPP MALE	BSPP MALE
RS44	BSPP MALE	BSPP MALE BULKHEAD
RS72P	BSPP MALE	BSPP FIXED FEMALE
RS72N	NPT MALE	NPT FIXED FEMALE
RS17	JIC MALE	JIC MALE
RS10	JIC MALE	JIC MALE BULKHEAD
RS16P	JIC MALE	BSPP FIXED FEMALE
RS16N	JIC MALE	NPT FIXED FEMALE
RS90	JIC MALE	UNO MALE (O RING BOSS)
RS98	JIC MALE	JIC/UNO FIXED FEMALE (O RING BOSS)
RS116	ORFS MALE	ORFS MALE
RS141	ORFS MALE	ORFS MALE BULKHEAD
RS173F	ORFS MALE	ORFS FIXED FEMALE

SIZE			WORKING PRESSURE	
INCH	DASH	EN	BAR	PSI
1/2"	-08	12	420	6,100
3/4"	-12	19	420	6,100
1"	-16	25	420	6,100
1.1/4"	-20	31	380	5,500

BSPP/BSPP

RS27P

RYCO IN-LINE SWIVEL
BSPP MALE
BSPP MALE

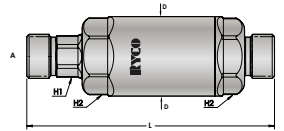

NOMINAL BODY SIZE		THREAD		DASH SIZE	PART NUMBER	LENGTH L	DIAMETER D	HEXAGON SIZE			
DN	inch	inch	inch					H1	inch	mm	inch
12	1/2	1/2	1/2	-0808	RS27P-0808	116,9	37,5	17,5	11/16	31,8	1.1/4
19	3/4	3/4	3/4	-1212	RS27P-1212	134,9	52,8	25,4	1	44,5	1.3/4
25	1	1	1	-1616	RS27P-1616	153,9	58,7	31,8	1.1/4	50,8	2
31	1.1/4	1.1/4	1.1/4	-2020	RS27P-2020	167,8	69,9	34,9	1.3/8	60,3	2.3/8

BSPP/BSPP

RS44

RYCO IN-LINE SWIVEL
BSPP MALE
BSPP MALE BULKHEAD

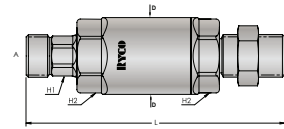

NOMINAL BODY SIZE		THREAD		DASH SIZE	PART NUMBER	LENGTH L	DIAMETER D	HEXAGON SIZE			
DN	inch	inch	inch					H1	inch	mm	inch
12	1/2	1/2	1/2	-0808	RS44-0808	136,9	37,5	17,5	11/16	31,8	1.1/4
19	3/4	3/4	3/4	-1212	RS44-1212	155,9	52,8	25,4	1	44,5	1.3/4
25	1	1	1	-1616	RS44-1616	175,9	58,7	31,8	1.1/4	50,8	2
31	1.1/4	1.1/4	1.1/4	-2020	RS44-2020	192,8	69,9	34,9	1.3/8	60,3	2.3/8

BSPP/BSPP

RS72P

RYCO IN-LINE SWIVEL
BSPP MALE
BSPP FIXED FEMALE

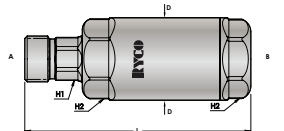

NOMINAL BODY SIZE		THREAD		DASH SIZE	PART NUMBER	LENGTH L	DIAMETER D	HEXAGON SIZE			
DN	inch	inch	inch					H1	inch	mm	inch
12	1/2	1/2	1/2	-0808	RS72P-0808	102,7	37,5	17,5	11/16	31,8	1.1/4
19	3/4	3/4	3/4	-1212	RS72P-1212	118,7	52,8	25,4	1	44,5	1.3/4
25	1	1	1	-1616	RS72P-1616	134,8	58,7	31,8	1.1/4	50,8	2
31	1.1/4	1.1/4	1.1/4	-2020	RS72P-2020	147,7	69,9	34,9	1.3/8	60,3	2.3/8

NPT/NPT

RS72N

RYCO IN-LINE SWIVEL
NPT MALE
NPT FIXED FEMALE

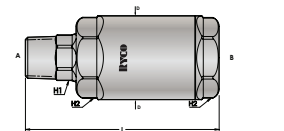

NOMINAL BODY SIZE		THREAD		DASH SIZE	PART NUMBER	LENGTH L	DIAMETER D	HEXAGON SIZE			
DN	inch	inch	inch					H1	inch	mm	inch
12	1/2	1/2	1/2	-0808	RS72N-0808	108,1	37,5	17,5	11/16	31,8	1.1/4
19	3/4	3/4	3/4	-1212	RS72N-1212	122,1	52,8	25,4	1	44,5	1.3/4
25	1	1	1	-1616	RS72N-1616	139,9	58,7	31,8	1.1/4	50,8	2
31	1.1/4	1.1/4	1.1/4	-2020	RS72N-2020	152,6	69,9	34,9	1.3/8	60,3	2.3/8

JIC/JIC

RS17

RYCO IN-LINE SWIVEL
JIC MALE
JIC MALE

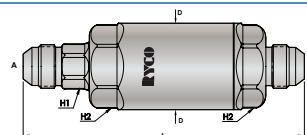

NOMINAL BODY SIZE		THREAD		DASH SIZE	PART NUMBER	LENGTH L	DIAMETER D	HEXAGON SIZE			
DN	inch	inch	inch					H1	inch	mm	inch
12	1/2	3/4	3/4	-1212	RS17-1212	122,0	37,5	17,5	11/16	31,8	1.1/4
19	3/4	1.1/16	1.1/16	-1717	RS17-1717	146,5	52,8	25,4	1	44,5	1.3/4
25	1	1.5/16	1.5/16	-2121	RS17-2121	162,0	58,7	31,8	1.1/4	50,8	2
31	1.1/4	1.5/8	1.5/8	-2626	RS17-2626	176,3	69,9	34,9	1.3/8	60,3	2.3/8

JIC/JIC

RS10

RYCO IN-LINE SWIVEL
JIC MALE
JIC MALE BULKHEAD

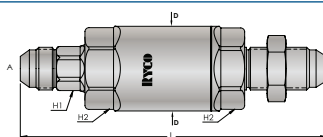

NOMINAL BODY SIZE		THREAD		DASH SIZE	PART NUMBER	LENGTH L	DIAMETER D	HEXAGON SIZE			
DN	inch	inch	inch					H1	inch	mm	inch
12	1/2	3/4	3/4	-1212	RS10-1212	142,7	37,5	17,5	11/16	31,8	1.1/4
19	3/4	1.1/16	1.1/16	-1717	RS10-1717	169,8	52,8	25,4	1	44,5	1.3/4
25	1	1.5/16	1.5/16	-2121	RS10-2121	184,0	58,7	31,8	1.1/4	50,8	2
31	1.1/4	1.5/8	1.5/8	-2626	RS10-2626	198,4	69,9	34,9	1.3/8	60,3	2.3/8

JIC/BSP

RS16P

RYCO IN-LINE SWIVEL
JIC MALE
BSP FIXED FEMALE

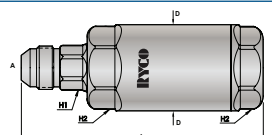

NOMINAL BODY SIZE		THREAD		DASH SIZE	PART NUMBER	LENGTH L	DIAMETER D	HEXAGON SIZE			
DN	inch	inch	inch					H1	inch	mm	inch
12	1/2	3/4	1/2	-1208	RS16P-1208	105,3	37,5	17,5	11/16	31,8	1.1/4
19	3/4	1.1/16	3/4	-1712	RS16P-1712	124,6	52,8	25,4	1	44,5	1.3/4
25	1	1.5/16	1	-2116	RS16P-2116	138,8	58,7	31,8	1.1/4	50,8	2
31	1.1/4	1.5/8	1.1/4	-2620	RS16P-2620	151,9	69,9	34,9	1.3/8	60,3	2.3/8

JIC/NPT

RS16N

RYCO IN-LINE SWIVEL
JIC MALE
NPT FIXED FEMALE

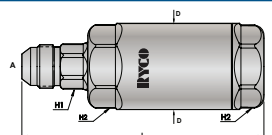

NOMINAL BODY SIZE		THREAD		DASH SIZE	PART NUMBER	LENGTH L	DIAMETER D	HEXAGON SIZE			
DN	inch	inch	inch					H1	inch	mm	inch
12	1/2	3/4	1/2	-1208	RS16N-1208	105,3	37,5	17,5	11/16	31,8	1.1/4
19	3/4	1.1/16	3/4	-1712	RS16N-1712	124,6	52,8	25,4	1	44,5	1.3/4
25	1	1.5/16	1	-2116	RS16N-2116	138,8	58,7	31,8	1.1/4	50,8	2
31	1.1/4	1.5/8	1.1/4	-2620	RS16N-2620	151,9	69,9	34,9	1.3/8	60,3	2.3/8

JIC/UNO (O RING BOSS)

RS90

RYCO IN-LINE SWIVEL
JIC MALE
UNO MALE (O RING BOSS)

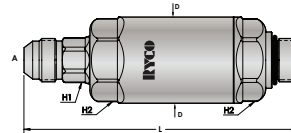

NOMINAL BODY SIZE		THREAD		DASH SIZE	PART NUMBER	LENGTH L	DIAMETER D	HEXAGON SIZE			
DN	inch	inch	inch					H1	inch	H2	mm
12	1/2	3/4	3/4	-1212	RS90-1212	119,1	37,5	17,5	11/16	31,8	1.1/4
19	3/4	1.1/16	1.1/16	-1717	RS90-1717	142,4	52,8	25,4	1	44,5	1.3/4
25	1	1.5/16	1.5/16	-2121	RS90-2121	157,4	58,7	31,8	1.1/4	50,8	2
31	1.1/4	1.5/8	1.5/8	-2626	RS90-2626	170,5	69,9	34,9	1.3/8	60,3	2.3/8

JIC/UNO (O RING BOSS)

RS98

RYCO IN-LINE SWIVEL
JIC MALE
JIC/UNO FIXED FEMALE (O RING BOSS)

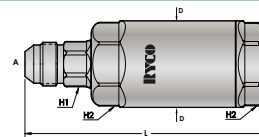

NOMINAL BODY SIZE		THREAD		DASH SIZE	PART NUMBER	LENGTH L	DIAMETER D	HEXAGON SIZE			
DN	inch	inch	inch					H1	inch	H2	mm
12	1/2	3/4	3/4	-1212	RS98-1212	105,3	37,5	17,5	11/16	31,8	1.1/4
19	3/4	1.1/16	1.1/16	-1717	RS98-1717	124,6	52,8	25,4	1	44,5	1.3/4
25	1	1.5/16	1.5/16	-2121	RS98-2121	138,8	58,7	31,8	1.1/4	50,8	2
31	1.1/4	1.5/8	1.5/8	-2626	RS98-2626	151,9	69,9	34,9	1.3/8	60,3	2.3/8

ORFS/ORFS

RS116

RYCO IN-LINE SWIVEL
ORFS MALE
ORFS MALE

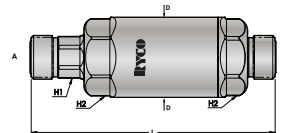

NOMINAL BODY SIZE		THREAD		DASH SIZE	PART NUMBER	LENGTH L	DIAMETER D	HEXAGON SIZE			
DN	inch	inch	inch					H1	inch	H2	mm
12	1/2	13/16	13/16	-1313	RS116-1313	114,2	37,5	17,5	11/16	31,8	1.1/4
19	3/4	1.3/16	1.3/16	-1919	RS116-1919	136,6	52,8	25,4	1	44,5	1.3/4
25	1	1.7/16	1.7/16	-2323	RS116-2323	150,7	58,7	31,8	1.1/4	50,8	2
31	1.1/4	1.11/16	1.11/16	-2727	RS116-2727	162,6	69,9	34,9	1.3/8	60,3	2.3/8

ORFS/ORFS

RS141

RYCO IN-LINE SWIVEL
ORFS MALE
ORFS MALE BULKHEAD

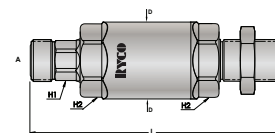

NOMINAL BODY SIZE		THREAD		DASH SIZE	PART NUMBER	LENGTH L	DIAMETER D	HEXAGON SIZE			
DN	inch	inch	inch					H1	inch	H2	mm
12	1/2	13/16	13/16	-1313	RS141-1313	138,0	37,5	17,5	11/16	31,8	1.1/4
19	3/4	1.3/16	1.3/16	-1919	RS141-1919	161,3	52,8	25,4	1	44,5	1.3/4
25	1	1.7/16	1.7/16	-2323	RS141-2323	175,3	58,7	31,8	1.1/4	50,8	2
31	1.1/4	1.11/16	1.11/16	-2727	RS141-2727	187,3	69,9	34,9	1.3/8	60,3	2.3/8

RYCO IN-LINE SWIVEL
ORFS MALE
ORFS FIXED FEMALE

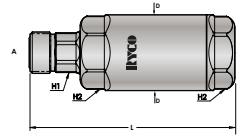

NOMINAL BODY SIZE		THREAD		DASH SIZE	PART NUMBER	LENGTH L	DIAMETER D	HEXAGON SIZE			
DN	inch	inch	inch					A	B	H1	H2
12	1/2	13/16	13/16	-1313	RS173F-1313	101,4	37,5	17,5	11/16	31,8	1.1/4
19	3/4	1.3/16	1.3/16	-1919	RS173F-1919	119,6	52,8	25,4	1	44,5	1.3/4
25	1	1.7/16	1.7/16	-2323	RS173F-2323	133,2	58,7	31,8	1.1/4	50,8	2
31	1.1/4	1.11/16	1.11/16	-2727	RS173F-2727	145,1	69,9	34,9	1.3/8	60,3	2.3/8



*Typical applications



THE **TOUGHEST**
COMBINATION THERE IS

RYCO IN-LINE SWIVEL
H6000 HOSE

PULSED AT 420 BAR / 6100 PSI WITH
ALTERNATING 90° ROTATION
FOR 500,000 CYCLES
AND STILL GOING